

## MEASUREMENTS

A:

B:

B1:

B2:

C:

C1:

D:

E:

F:

G:

M:

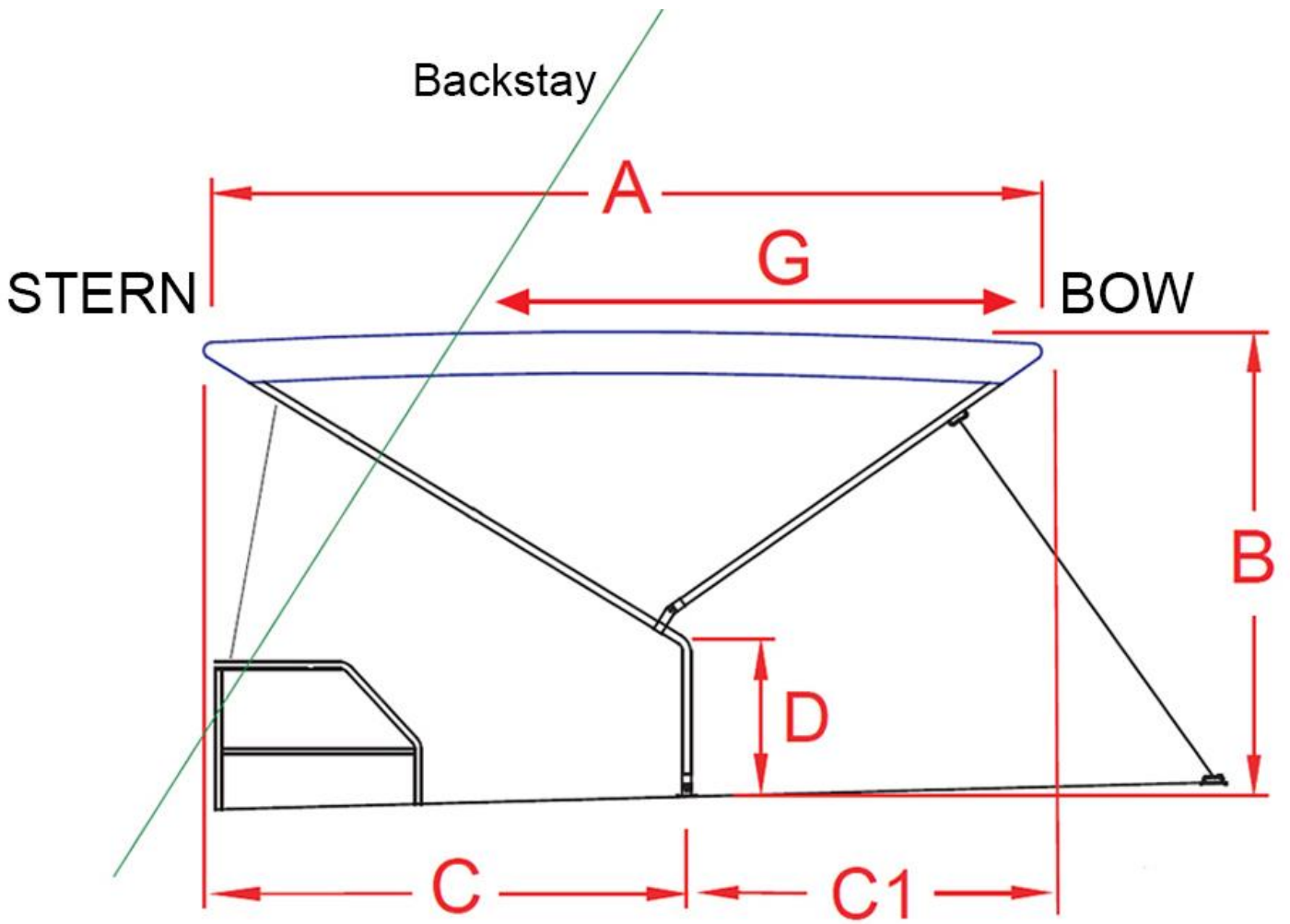

$$A = C + C1$$

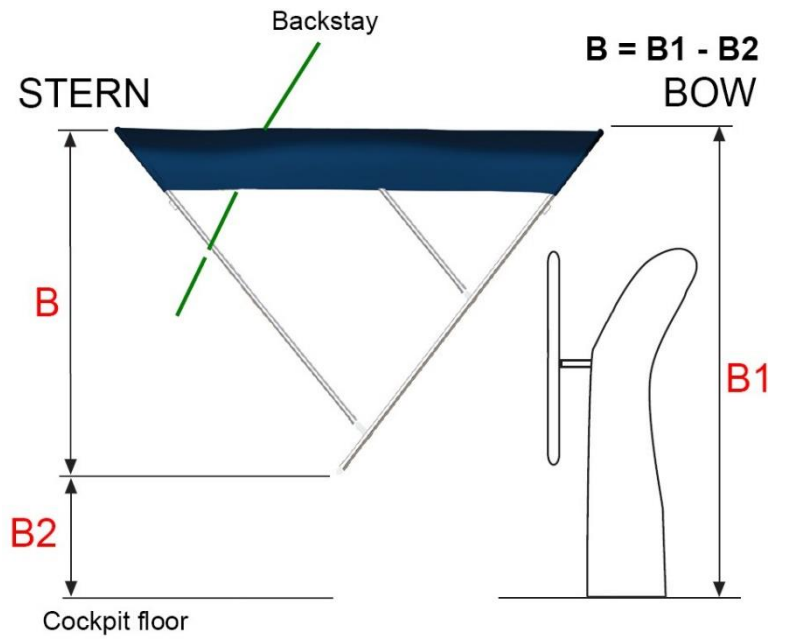
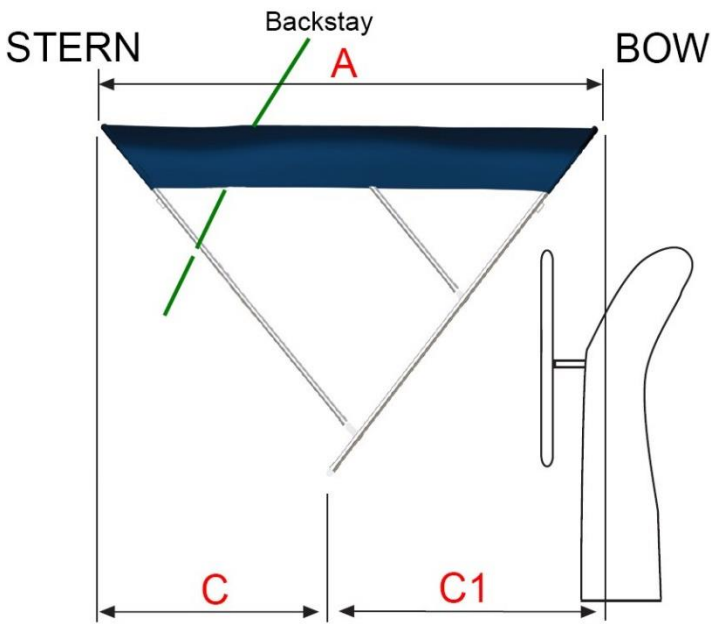

$$B = B1 - B2$$

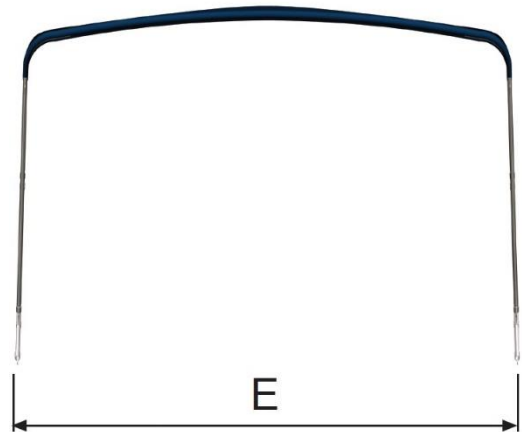
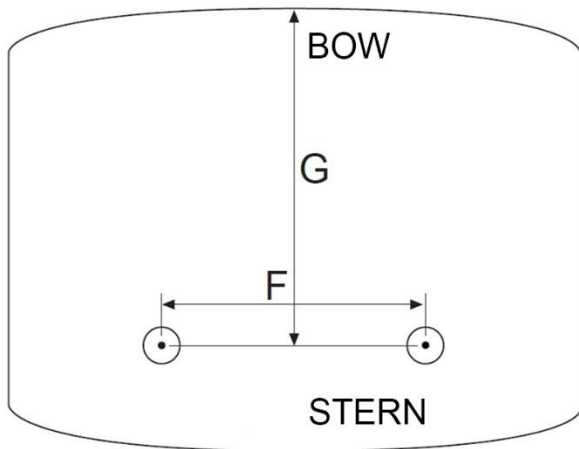
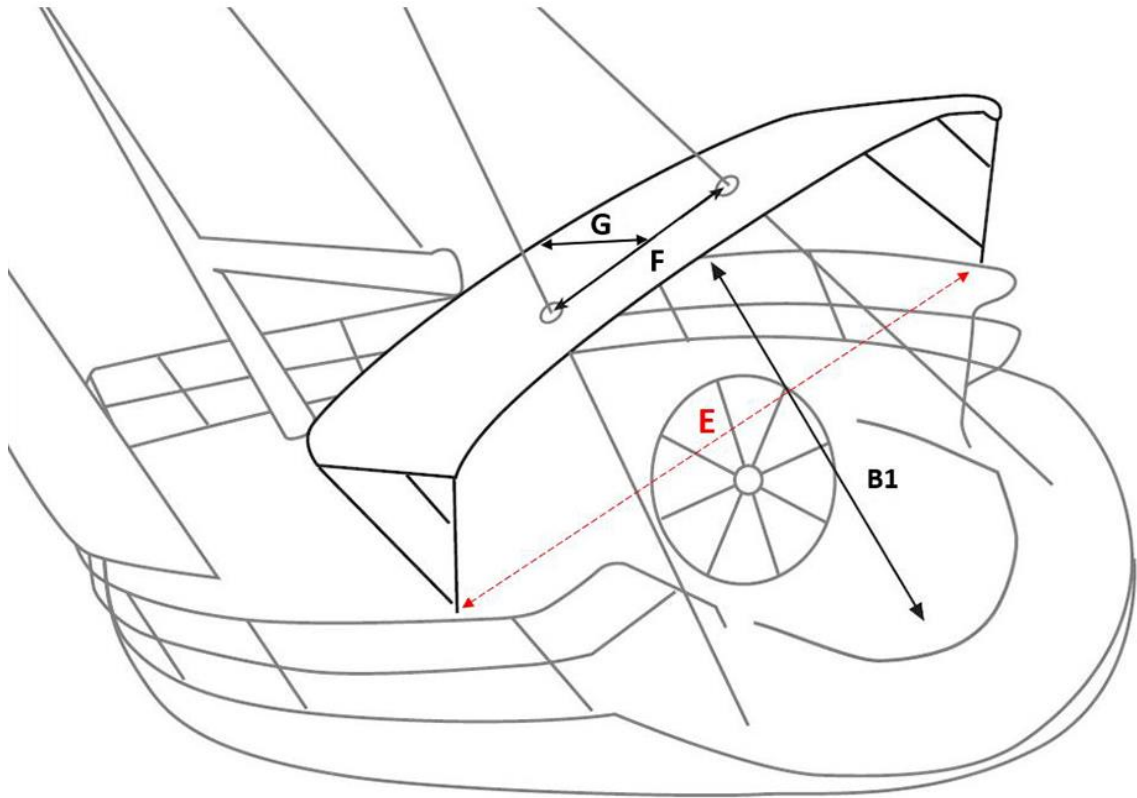

STERN

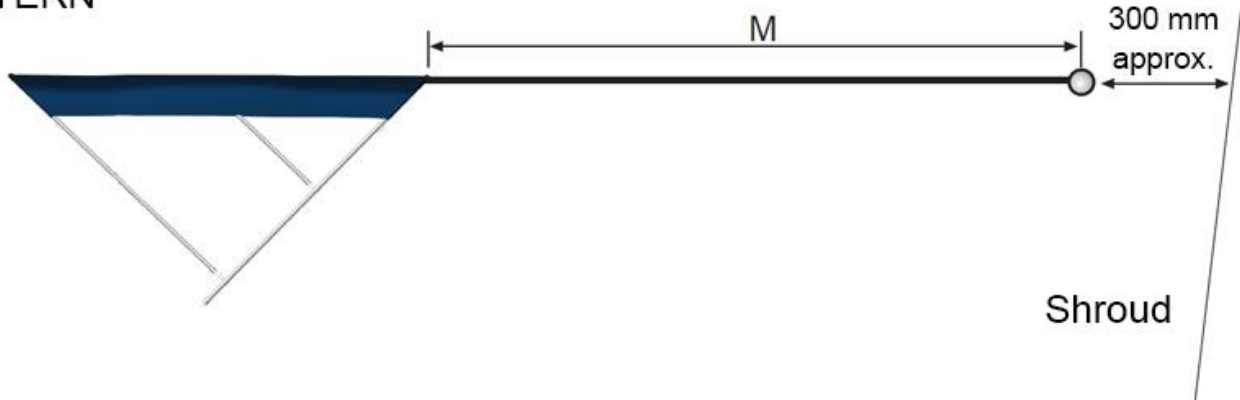

BOW

Mast

Shroud